

BI-DIRECTIONAL FLOW RATE INDICATOR / TOTALIZER

WITH ANALOG, PULSE SIGNAL AND
FLOW DIRECTION OUTPUTS



Features

- Ability to detect flow direction with quadrature signal inputs.
- Displays positive and negative flow rate ref. flow direction.
- Total and accumulated total count up and count down ref. flow direction.
- Large 17mm (0.67") digit selection for flow rate or total.
- Selectable on-screen engineering units; volumetric or mass.
- Auto backup of settings and running totals.
- Operational temperature -40°C up to +80°C (-40°F up to 176°F).
- Very compact design for panel mount, wall mount or field mount applications.
- Rugged aluminum field mount enclosure IP67 / NEMA4X.
- Intrinsically Safe - ATEX and IECEx approval for gas and dust applications.
- Explosion/flame proof Ex II 2 GD EEx d IIB T5.
- Full Modbus communication RS232/485/TTL.
- Loop or battery powered, 8 - 24V AC/DC or 115 - 230V AC power supply.
- Sensor supply 3.2 / 8.2 / 12 / 24V DC.

Signal output

- (0)4 - 20mA / 0 - 10V DC according to positive and/or negative flow rate.
- Scaled pulse output according to accumulated total - count up and count down.
- Switch output related to flow direction and accumulated total.

Signal input

Flow

- Reed-switch.
- NAMUR.
- NPN/ PNP pulse.
- Sine wave (coil).
- Active pulse signals.

Applications

- Bi-directional flow measurement applications like loading / unloading through the same flowmeter or where undesired backflow disturbs a correct totalisation.

General information

Introduction

The F115 has been developed for applications where the direction of flow is an issue. Applications can be found by loading and unloading of ships where one bi-directional flowmeter is used. An other application is the correction of back-flow due to shocks in a pipeline caused by piston pumps or valve behavior. It is required to offer two pulse signals from the flowmeter which are 90° or 240° degrees out of phase. A wide selection of options further enhances this models capabilities.

Display

The display has large 17mm (0.67") and 8mm (0.31") digits which can be set to show flow rate and totals. On-screen engineering units are easily configured from a comprehensive menu. In case of a reverse flow, the flow rate will be displayed as a negative value. The totalizers will count down.

Configuration

All configuration settings are accessed via a simple operator menu which can be pass-code protected. Each setting is clearly indicated with an alpha-numerical description, which avoids confusing abbreviations and baffling codes. Once familiar with one F-series product, you will be able to program all models in the series without a manual. All settings and totals are safely stored in EEPROM memory in the event of sudden power failure.

Analog output signal

The positive and / or negative flow rate is re-transmitted with the (0)4 - 20mA or 0 - 10V DC output signal. The output signal is updated ten times per second. The output value is user defined in relation to the flow rate, e.g. 4mA equals to 0L / Hr and 20mA equals to + or -200L / Hr. The output signal can be passive, active or isolated where the passive output type will loop power the F115.

Pulse output

The scaleable pulse output, reflects the count on the accumulated display. Moreover, if the transmitted pulse reflects a count-down situation due to reverse flow, the second output will be switched. The pulse length is user defined from 0.008 second up to 2 seconds. The maximum output frequency is 64Hz. The output signal can be a passive NPN, active PNP or an isolated electro-mechanical relay.

Signal input

The F115 accepts most pulse input signals for volumetric flow or mass flow measurement. To detect the direction of flow, it is required to offer two signals 90° or 240° out of phase. The input signal types can be selected for both inputs in the configuration menu without having to adjust any sensitive mechanical dip-switches or jumpers. Different types of sensors are allowed for both inputs.

Communication

All process data and settings can be read and modified manually or through the Modbus communication link (RS232 / RS485). Full Modbus functionality remains available for the Intrinsically Safe version (TTL).

Hazardous areas

This model has been ATEX and IECEx certified Intrinsically Safe for gas and dust applications, with an allowed operational temperature of -40°C to +70°C (-40°F to +158°F). A flame proof enclosure with ATEX certification offers the rating $\text{Ex II 2 GD EEx d IIB T5}$.

Enclosures

Various types of enclosures can be selected, all ATEX and IECEx approved. As standard the F115 is supplied in an GRP panel mount enclosure, which can be converted to an GRP field mount enclosure. Most popular is our rugged aluminum field mount enclosure with IP67 / NEMA 4X rating. Both European or U.S. cable gland entry threads are available.

Overview application F115

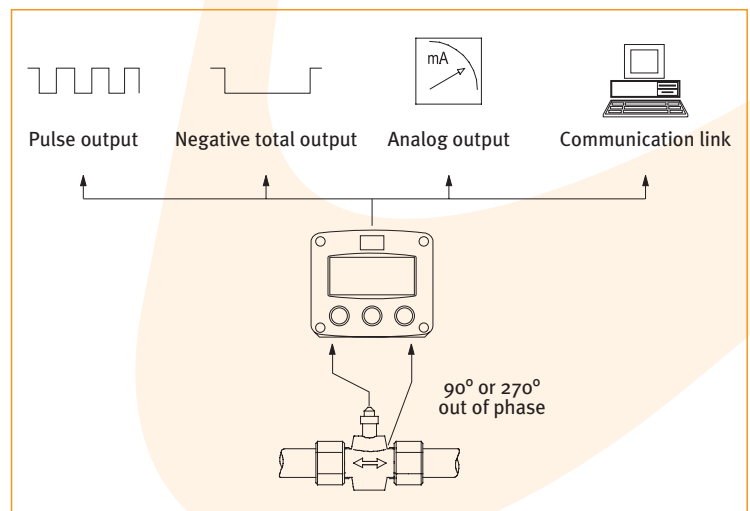

Dimensions enclosures

Aluminum & GRP panel mount enclosure

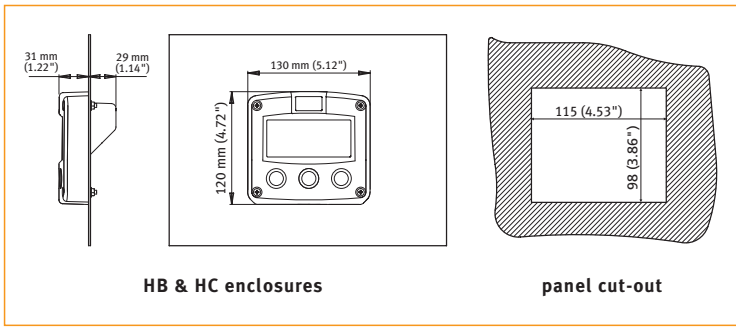

Aluminum & GRP field / wall mount enclosures

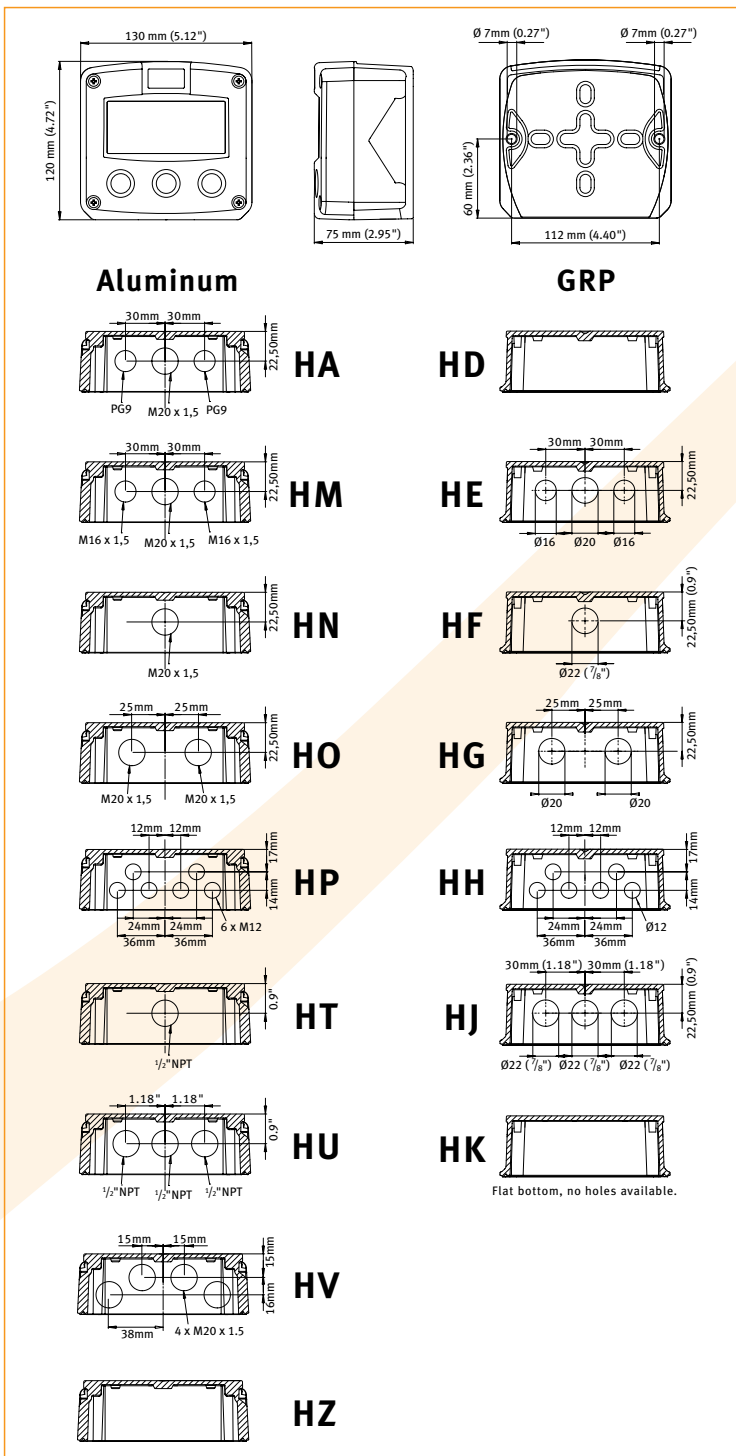

Terminal connections

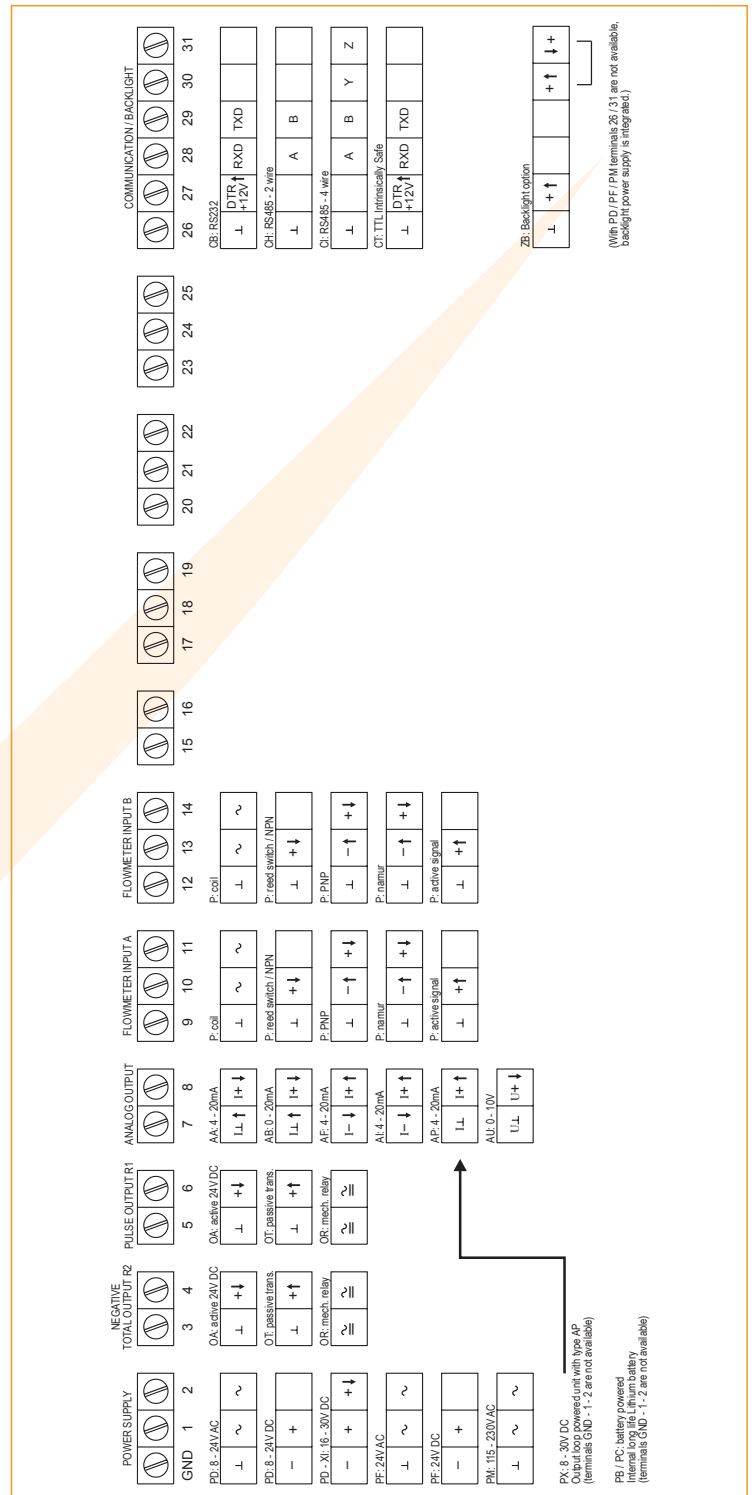

Display example - 90 x 40mm (3.5" x 1.6")



Typical wiring diagram F115-P-(AP)-CH-(OT)-PB

Typical wiring diagram F115-P-AP-CH-OT-PX

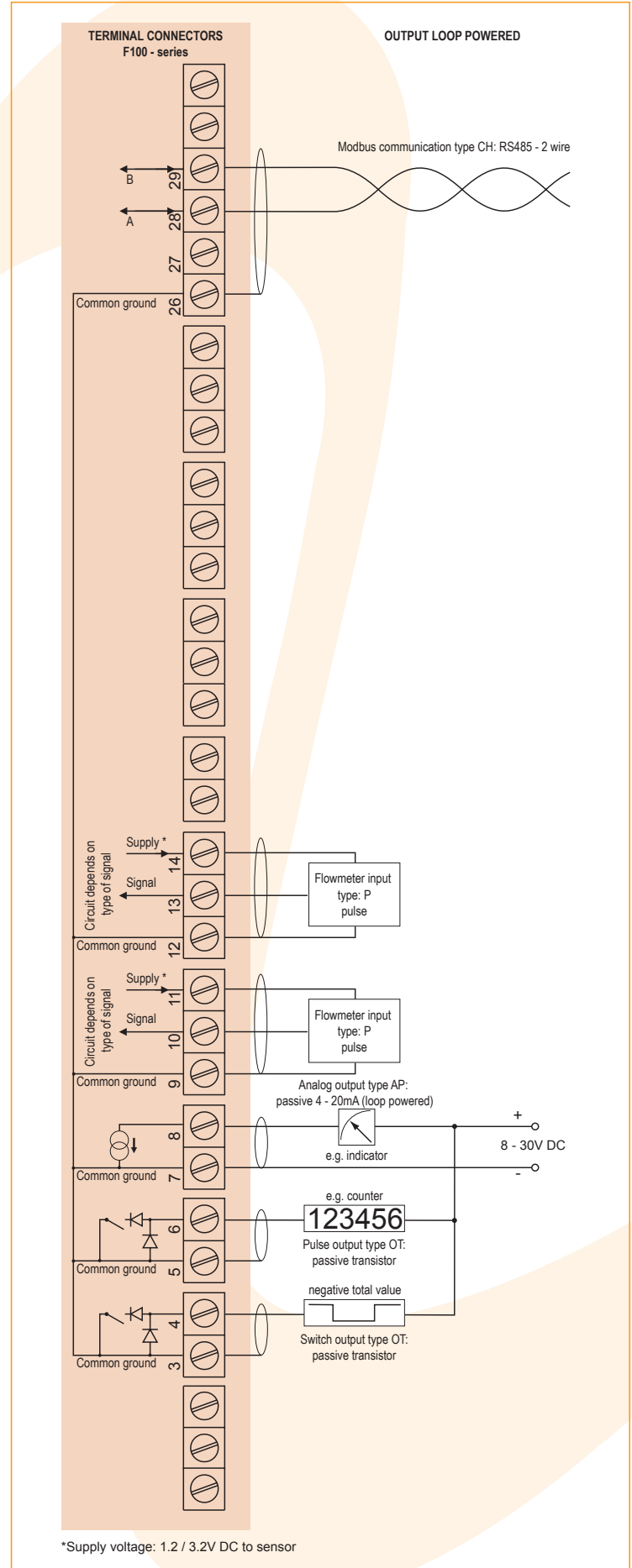
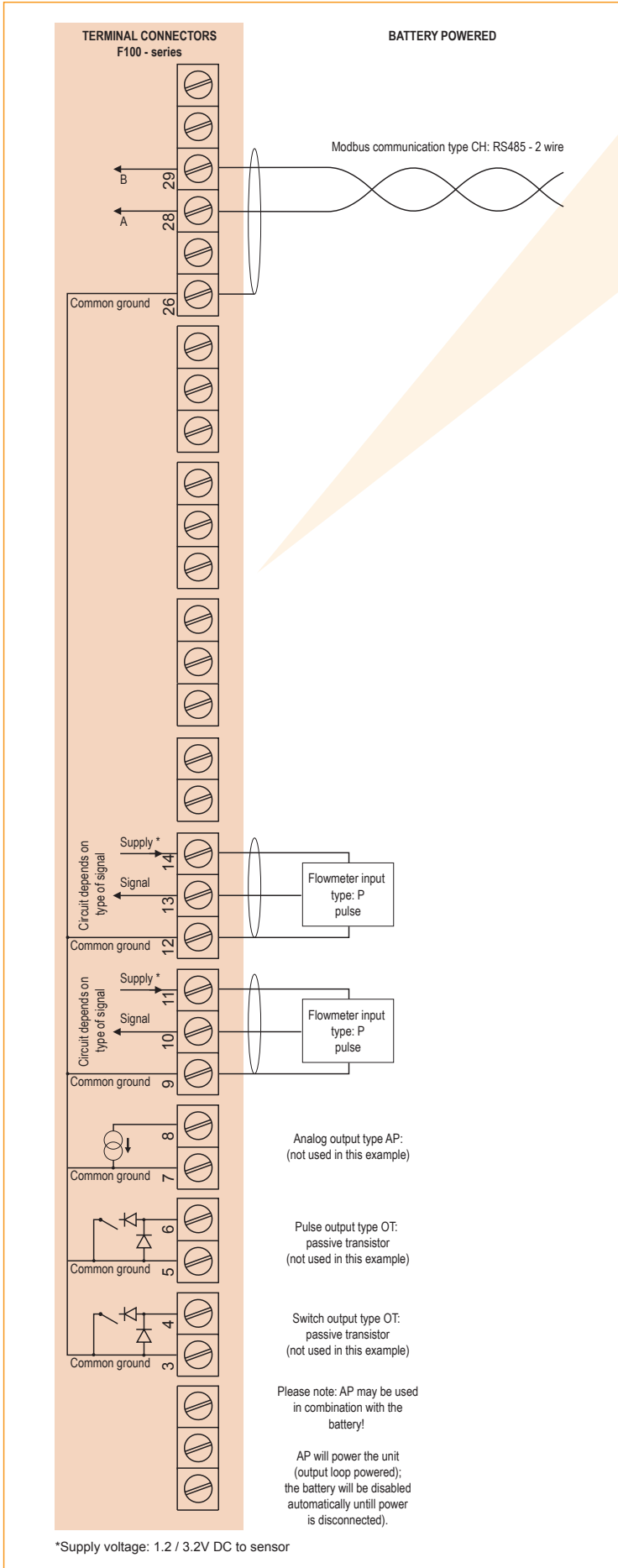

Typical wiring diagram F115-P-AA-CB-OA-PD

Typical wiring diagram F115-P-AI-CI-OR-PM

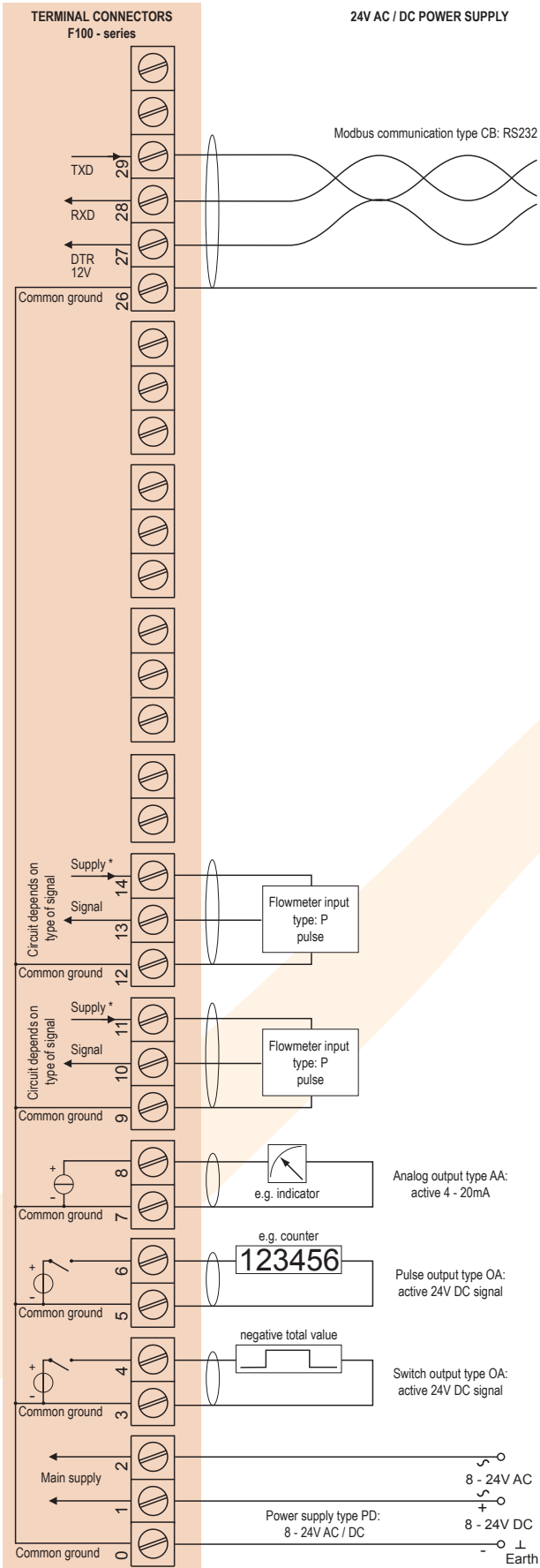

*Supply voltage: 1.2 / 3.2 / 8.2 / 12 / 24V DC to sensor

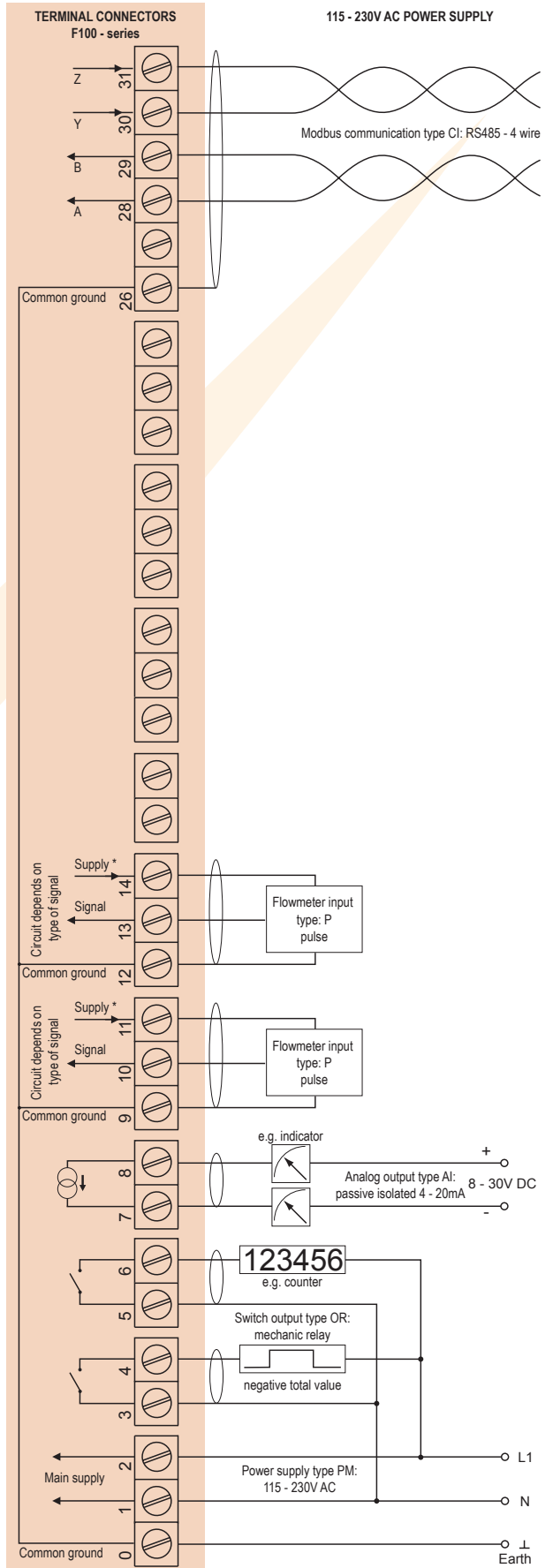

*Supply voltage: 1.2 / 3.2 / 8.2 / 12 / 24V DC to sensor

Hazardous area applications

The F115-XI has been certified according ATEX and IECEx by DEKRA for use in Intrinsically Safe applications with an ambient temperature of -40°C to +70°C (-40°F to +158°F).

- The ATEX markings for gas and dust applications are:

II 1 G Ex ia IIB/IIC T4 Ga
II 1 D Ex ia IIIC T100 C Da IP6X.

- The IECEx markings for gas and dust applications are: **Ex ia IIC/IIB T4 Ga** and **Ex ia IIIC T100 C Da IP6X.**

Besides the two I.S. power supply for the pulse and flow-direction outputs, it is allowed to connect up to four I.S. power supplies in IIB/IIIC applications or one in IIC applications. Consult the certificate for the maximum input and output values of the circuits. Full functionality of the F115 remains available, including 4 - 20mA output, pulse and flow-direction outputs and Modbus communication (type CT). Power supply type PD-XI offers a 8.2V sensor supply e.g. for one Namur sensor. A flame proof enclosure with rating ATEX **II 2 GD EEx d IIB T5** is available as well. Please contact your supplier for further details.

Certificate of conformity KEMA 03ATEX1074 X

- IECEx DEK 11.0042X



Configuration example IIB / IIIC and IIC

F115-P-(AP)-(CT)-(OT)-PC-XI - Battery powered unit

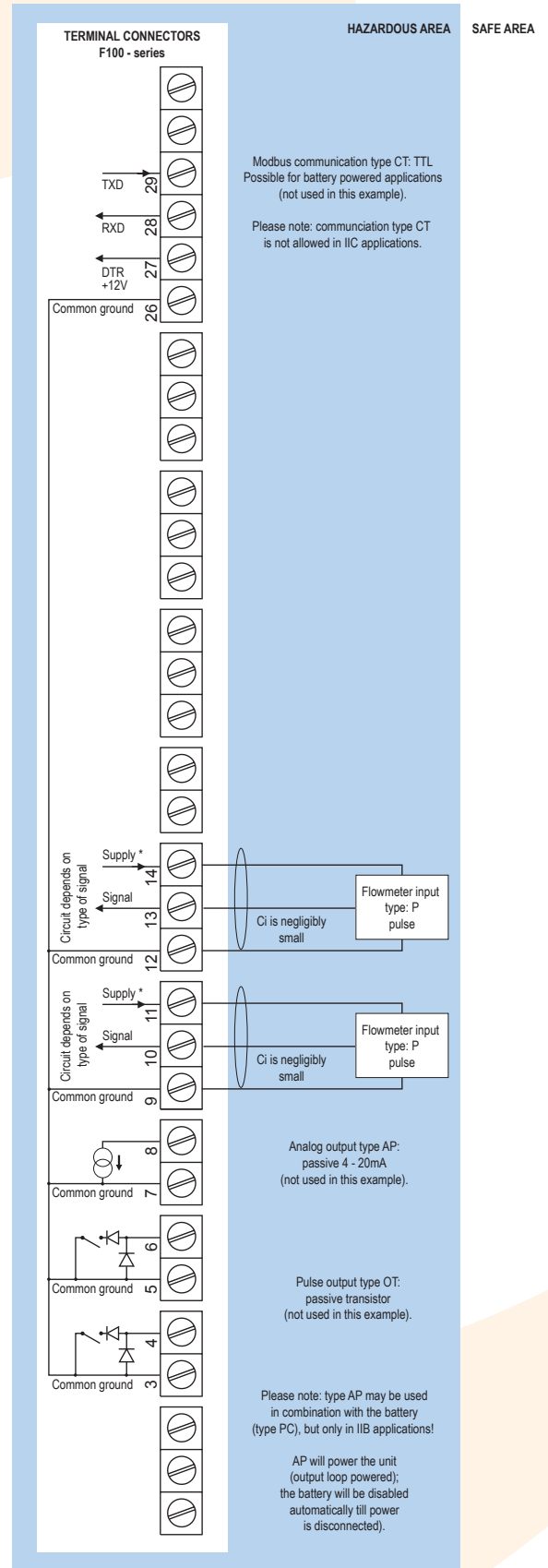

* Note sensor supply voltage: 1.2V DC for coil sensors or 3.2V DC for other pulse sensors.

Configuration example IIB / IIIC and IIC - F115-P-AP-(CT)-OT-PX-XI - Output loop powered

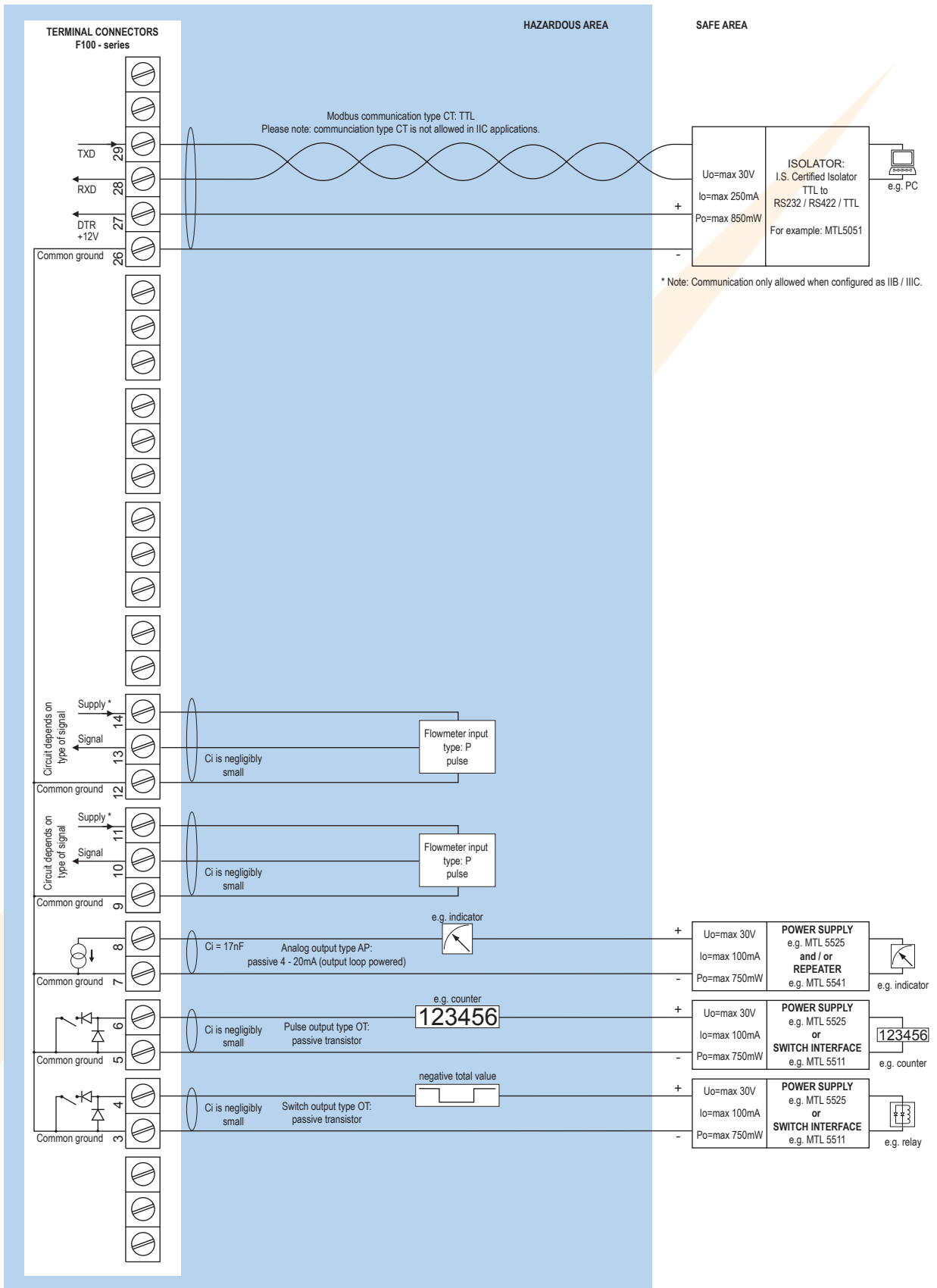

* Note sensor supply voltage: 1.2V DC for coil sensors or 3.2V DC for other pulse sensors.

Configuration example IIB / IIIC and IIC - F115-P-AF-(CT)-OT-PD-XI - Power supply 16 - 30V DC

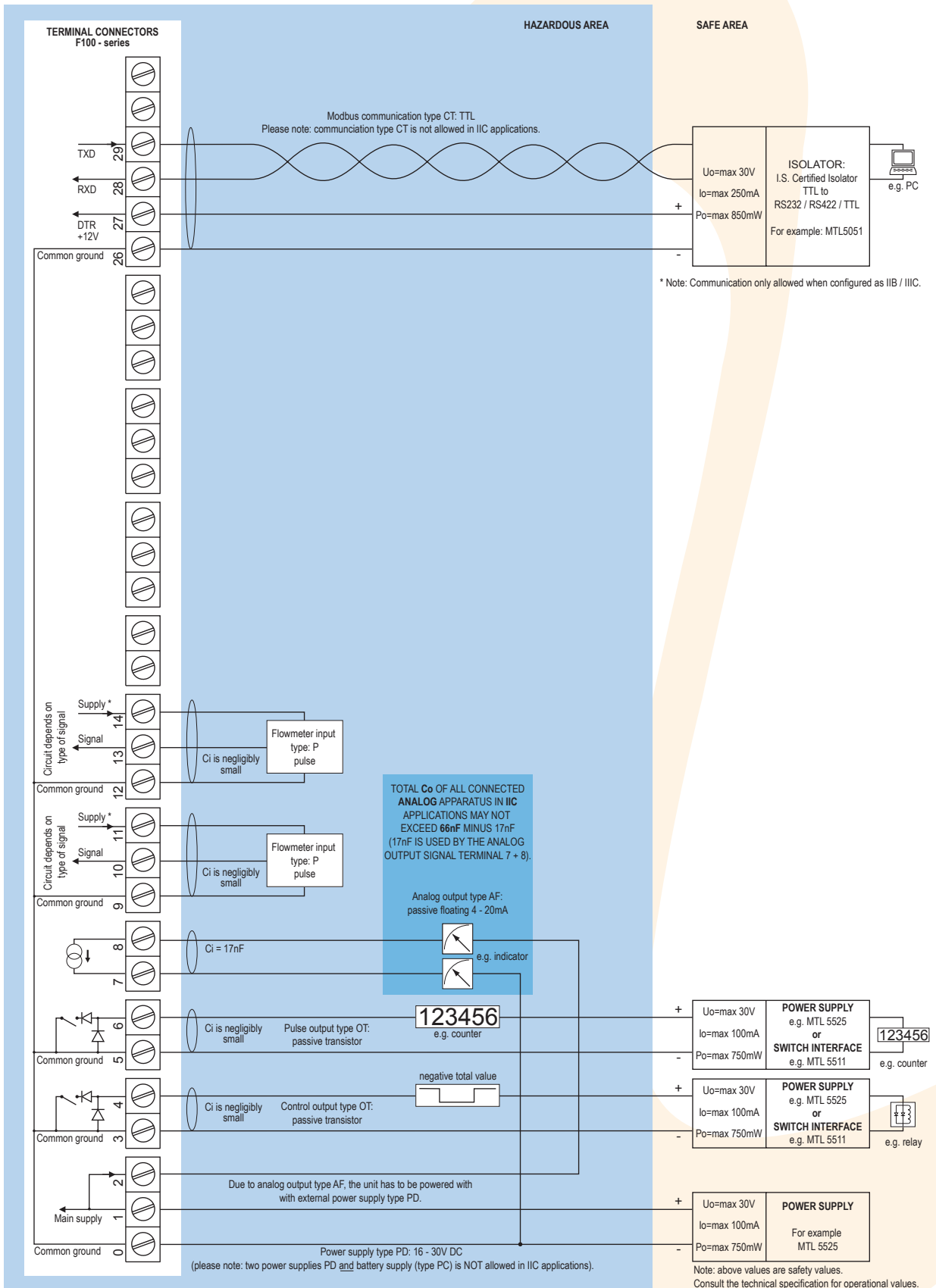

* Note power supply type PD: the supply voltage to pulse sensors is maximum 8.7V (U_o=max 8.7V I_o=max 25mA P_o=max 150mW) and to analog sensors as connected to terminal 1 (internally linked).

Configuration example IIB / IIIC - F115-P-AP-CT-OT-(PD)-XI - Power supply 16 - 30V DC

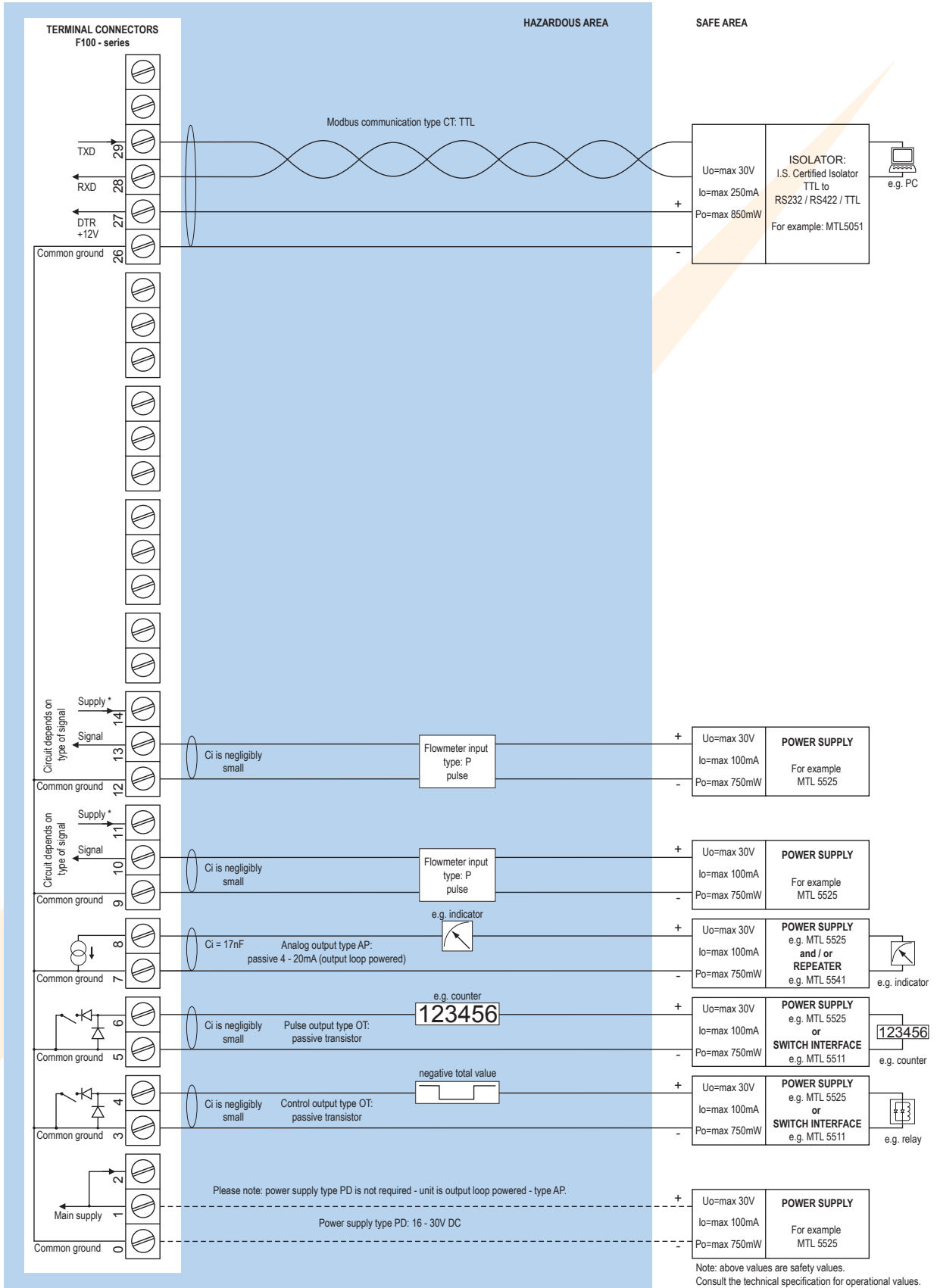

Technical specification

General

Display	
Type	High intensity reflective numeric and alphanumeric LCD, UV-resistant.
Dimensions	90 x 40mm (3.5" x 1.6").
Digits	Seven 17mm (0.67") and eleven 8mm (0.31") digits. Various symbols and measuring units.
Refresh rate	User definable: 8 times/sec. - 1 time/30 secs.
Option ZB	Transflective LCD with green LED backlight. Good readings in full sunlight and darkness.
Note ZB	Only available for safe area applications.

Operating temperature

Standard unit	-40°C to +80°C (-40°F to +176°F).
Intrinsically Safe	-40°C to +70°C (-40°F to +158°F).

Power requirements

Type PB	Long life Lithium battery - life-time depends upon settings and configuration - up to 5 years.
Type PC	Intrinsically Safe long life lithium battery - life-time depends upon settings and configuration - up to 5 years.
Type PD	8 - 24V AC / DC ± 10%. Power consumption max. 10 Watt. Intrinsically Safe: 16 - 30V DC; power consumption max. 0.75 Watt.
Type PF	24V AC / DC ± 10%. Power consumption max. 15 Watt.
Type PM	115 - 230V AC ± 10%. Power consumption max. 15 Watt.
Type PX	8 - 30V DC. Power consumption max. 0.5 Watt.
Type ZB	12 - 24V DC ± 10% or internally powered with type PD / PF / PM. Power consumption max. 1 Watt.
Note PB/PF/PM	Not available Intrinsically Safe.
Note PF/PM	The total consumption of the sensors and outputs may not exceed 400mA @ 24V.
Note	For Intrinsically Safe applications, consult the safety values in the certificate.

Sensor excitation

Type PB/PC/PX	3.2V DC for pulse signals and 1.2V DC for coil pick-up.
Note	This is not a real sensor supply. Only suitable for sensors with a very low power consumption like coils (sine wave) and reed-switches.
Type PD	1.2 / 3.2 / 8.2 / 12 / 24V DC - max. 50mA @ 24V DC.
Type PD-XI	1.2 / 3.2 / 8.2V DC - max. 7mA @ 8.2V DC and mains power supply voltage (as connected to terminal 1).
Type PF / PM	1.2 / 3.2 / 8.2 / 12 / 24V DC - max. 400mA @ 24V DC.

Terminal connections

Type	Removable plug-in terminal strip. Wire max. 1.5mm ² and 2.5mm ² .
------	---

Data protection

Type	EEPROM backup of all settings. Backup of running totals every minute. Data retention at least 10 years.
Pass-code	Configuration settings can be pass-code protected.

Casing

General

Window	Polycarbonate window.
Sealing	Silicone.
Control keys	Three industrial micro-switch keys. UV-resistant silicone keypad.

Aluminum wall / field mount enclosures

General	Die-cast aluminum wall/field mount enclosure IP67 / NEMA 4X with 2-component UV-resistant coating.
Dimensions	130 x 120 x 75mm (5.12" x 4.72" x 2.95") - W x H x D.
Weight	1100 gr.
Type HA	Cable entry: 2 x PG9 and 1 x M20.
Type HM	Cable entry: 2 x M16 and 1 x M20.
Type HN	Cable entry: 1 x M20.
Type HO	Cable entry: 2 x M20.
Type HP	Cable entry: 6 x M12.
Type HT	Cable entry: 1 x 1/2" NPT.
Type HU	Cable entry: 3 x 1/2" NPT.
Type HV	Cable entry: 4 x M20.
Type HZ	Cable entry: no holes.

GRP wall / field mount enclosures

General	GRP wall/field mount enclosure IP67 / NEMA 4X, UV-resistant and flame retardant.
Dimensions	130 x 120 x 75mm (5.12" x 4.72" x 2.95") - W x H x D.
Weight	600 gr.
Type HD	Cable entry: no holes.
Type HE	Cable entry: 2 x Ø 16mm and 1 x Ø 20mm.
Type HF	Cable entry: 1 x Ø 22mm (7/8").
Type HG	Cable entry: 2 x Ø 20mm.
Type HH	Cable entry: 6 x Ø 12mm.
Type HJ	Cable entry: 3 x Ø 22mm (7/8").
Type HK	Flat bottom, cable entry: no holes.

Panel mount enclosures



Dimensions	130 x 120 x 60mm (5.12" x 4.72" x 2.36") - W x H x D.
Panel cut-out	115 x 98mm (4.53" x 3.86") L x H.
Type HB	Die-cast aluminum panel mount enclosure IP65 / NEMA 4X.
Weight	600 gr.
Type HC	GRP panel mount enclosure IP65 / NEMA 4X, UV-resistant and flame retardant.
Weight	450 gr.

ABS wall / field mount enclosures

General	Silicone free ABS wall/field mount enclosure IP65 with EPDM and PE sealings. UV-resistant polyester keypad (old HD enclosure).
Dimensions	130 x 114 x 71mm (5.1" x 4.5" x 2.8") - W x H x D.
Weight	450 gr.
Type HS	Cable entry: no holes.

Hazardous area

Intrinsically Safe (Type XI)

ATEX certification	 II 1 G Ex ia IIB/IIC T4 Ga. II 1 D Ex ia IIIC T100 °C Da IP6X.
IECEX certification	 Ex ia IIC/IIB T4 Ga. Ex ia IIIC T100 °C Da IP6X.
Ambient Ta	-40°C to +70°C (-40°F to +158°F).

Explosion proof (Type XF)

ATEX certification	 II 2 GD EEx d IIB T5.
Dimensions	300 x 250 x 200mm (11.8" x 9.9" x 7.9") L x H x D.
Weight	Appr. 15kg.

Environment

Electromagnetic compatibility	Compliant ref: EN 61326 (1997), EN 61010-1 (1993).
-------------------------------	--

Signal inputs

Flowmeter

Type P	Coil / sine wave (minimum 20mVpp or 80mVpp - sensitivity selectable), NPN/PNP, open collector, reed-switch, Namur, active pulse signals 8 - 12 and 24V DC.
Note	Different sensor types can be used for both inputs.
Frequency	Minimum 0Hz - maximum 7kHz for total and flow rate. Maximum frequency depends on signal type and internal low-pass filter. E.g. reed switch with low-pass filter: max. frequency 120Hz.
K-Factor	0.000010 - 9,999,999 with variable decimal position.
Low-pass filter	Available for all pulse signals.
Option ZF	coil sensitivity 10mVpp.

Signal outputs

Analog output

Function	Transmitting positive (and negative) flow rate.
Accuracy	10 bit. Error < 0.05%. Analog output signal can be scaled to any desired range.
Update time	Ten times per second.
Type AA	Active 4 - 20mA output (requires PD, PF or PM).
Type AB	Active 0 - 20mA output (requires PD, PF or PM).
Type AF	Passive floating 4 - 20mA output for Intrinsically Safe applications (requires XI + PC or PD).
Type AI	Passive galvanically isolated 4 - 20mA output - also available for battery powered models (requires PB, PD, PF or PM).
Type AP	Passive 4 - 20mA output - not isolated. Unit will be loop powered.
Type AU	Active 0 - 10V DC output (requires PD, PF or PM).

Pulse output

Function	Pulse output and indication negative totalisation.
Frequency	Max. 64Hz. Pulse length user definable between 7.8 msec up to 2 seconds.
Type OA	Two active 24V DC transistor outputs (PNP); max. 50mA per output (requires PD, PF or PM).
Type OR	Two electro-mechanical relay outputs (N.O.) - isolated; max. switch power 230V AC - 0.5A per relay (requires PF or PM).
Type OT	Two passive transistor outputs (NPN) - not isolated. Max. 50V DC - 300mA per output.
Note	Output 2 is switched in case a negative acc. total is transmitted.

Communication option

Function	Reading display information, reading / writing all configuration settings.
Protocol	Modbus RTU.
Speed	1200 - 2400 - 4800 - 9600 baud.
Addressing	Maximum 255 addresses.
Type CB	RS232
Type CH	RS485 2-wire
Type CI	RS485 4-wire
Type CT	TTL Intrinsically Safe.

Operational

Operator functions

Displayed functions	<ul style="list-style-type: none"> Positive and negative flow rate. Total and accumulated total (count up and down). Total can be reset to zero by pressing the CLEAR-key twice.
---------------------	---

Total

Digits	7 digits.
Units	L, m ³ , GAL, USGAL, kg, lb, bbl, no unit.
Decimals	0 - 1 - 2 or 3.
Note	Total can be reset to zero.

Accumulated total

Digits	11 digits.
Units / decimals	According to selection for total.
Note	Can not be reset to zero.

Flow rate

Digits	7 digits.
Units	mL, L, m ³ , Gallons, kg, Ton, lb, bl, cf, RND, ft ³ , scf, Nm ³ , NI, igal - no units.
Decimals	0 - 1 - 2 or 3.
Time units	/sec - /min - /hr - /day.

Accessories

Mounting accessories

ACFo2	Stainless steel wall mounting kit.
ACFo5	Stainless steel pipe mounting kit (worm gear clamps not included).
ACFo6	Two stainless steel worm gear clamps Ø 44 - 56mm.
ACFo7	Two stainless steel worm gear clamps Ø 58 - 75mm.
ACFo8	Two stainless steel worm gear clamps Ø 77 - 95mm.
ACFo9	Two stainless steel worm gear clamps Ø 106 - 138mm.
ACF10	Customized Grevopal tagplates for ACFo2 and ACFo5, including stainless steel screws. Dimension: 95mm x 12.5mm (3.75" x 0.50").

Cable gland accessories

ACF20	For HA enclosure, includes O-rings.
ACF25	For HE enclosure, includes locknuts and O-rings.
ACF26	For HF enclosure, includes locknuts and O-rings.
ACF27	For HG enclosure, includes locknuts and O-rings.
ACF28	For HH enclosure, includes locknuts and O-rings.
ACF29	For HJ enclosure, includes locknuts and O-rings.
ACF32	For HM enclosure, includes O-rings.
ACF33	For HN enclosure, includes O-rings.
ACF34	For HO enclosure, includes O-rings.
ACF35	For HP enclosure, includes O-rings.
ACF39	For HT enclosure, includes O-rings.
ACF40	For HU enclosure, includes O-rings.

Ordering information

Standard configuration: F115-P-AP-CX-EX-HC-IX-OT-PX-TX-XX-ZX.

Ordering information: F115 - _ -A _ -C _ -EX -H _ -IX -O _ -P _ -TX -X _ -Z _

Flowmeter input signal

P  **Pulse input: coil, npn, pnp, namur, reed-switch.**

Analog output signal

AA Active 4 - 20mA output - requires PD, PF or PM.

AB Active 0 - 20mA output - requires PD, PF or PM.

AF  I.S. floating 4 - 20mA output - requires XI + PC or PD.

AI Isolated 4 - 20mA output - requires PB, PD, PF or PM.

AP  **Passive 4 - 20mA output, loop powered unit.**

AU Active 0 - 10V DC output - requires PD, PF or PM.

Communication

CB Communication RS232 - Modbus RTU.

CH Communication RS485 - 2-wire - Modbus RTU.

CI Communication RS485 - 4-wire - Modbus RTU.

CT  Intrinsically Safe TTL - Modbus RTU.

CX  **No communication.**

Flow equations

EX  **No flow equations.**

Panel mount enclosures - IP65 / NEMA4X

HB  Aluminum enclosure.

HC  **GRP enclosure.**

GRP field / wall mount enclosures - IP67 / NEMA4X

HD  Cable entry: no holes.

HE  Cable entry: 2 x Ø 16mm & 1 x Ø 20mm.

HF  Cable entry: 1 x Ø 22mm (7/8").

HG  Cable entry: 2 x Ø 20mm.

HH  Cable entry: 6 x Ø 12mm.

HJ  Cable entry: 3 x Ø 22mm (7/8").

HK  Flat bottom, cable entry: no holes.

Aluminum field / wall mount enclosures - IP67 / NEMA4X

HA  Cable entry: 2 x PG9 flow rate 1 x M20.

HM  Cable entry: 2 x M16 flow rate 1 x M20.

HN  Cable entry: 1 x M20.

HO  Cable entry: 2 x M20.

HP  Cable entry: 6 x M12.

HT  Cable entry: 1 x 1/2" NPT.

HU  Cable entry: 3 x 1/2" NPT.

HV  Cable entry: 4 x M20.

HZ  Cable entry: no holes.

ABS field / wall mount enclosures - IP65

HS  Silicone free ABS field enclosure – Cable entry: no holes (old HD enclosure).

Additional inputs

IX  **No additional input.**

Outputs

OA Two active transistor outputs - requires PD, PF or PM.

OR Two mechanical relay outputs - requires PF or PM.

OT  **Two passive transistor outputs - standard configuration.**

Power supply

PB Lithium battery powered.

PC  Lithium battery powered - Intrinsically Safe.

PD  8 - 24V AC/DC + sensor supply - with XI: 16 - 30V DC.

PF 24V AC/DC + sensor supply.

PM 115 - 230V AC + sensor supply.

PX  **Basic power supply 8 - 30V DC (no real sensor supply). Unit requires external loop AP.**

Temperature input signal

TX  **No temperature input signal.**

Hazardous area

XI  Intrinsically Safe, according ATEX and IECEx.

XF EExd enclosure - 3 keys.

XX **Safe area only.**

Other options

ZB Backlight.

ZF  Coil input 10mVpp.

ZX  **No options.**

The bold marked text contains the standard configuration.

 Available Intrinsically Safe.

Specifications are subject to change without notice.